

* به پدر و مادر خود نیکی کنید.
قرآن کریم

بخش ۱

نگاره‌ها

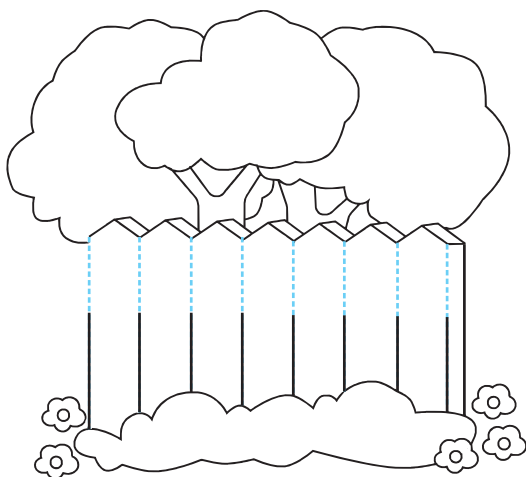

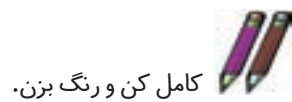
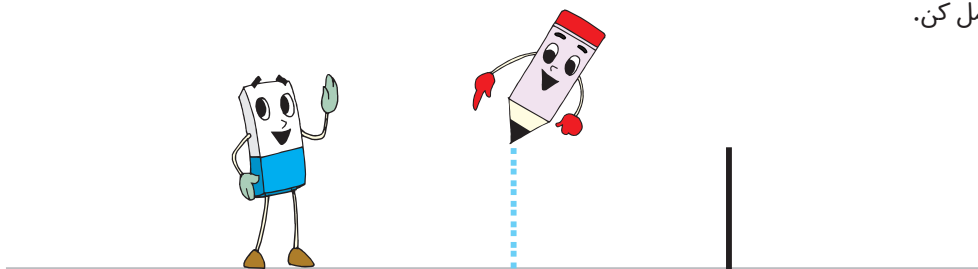



Four horizontal lines for writing, with a vertical line and a downward arrow on the right side of the top line. On the left side, there are four empty boxes for writing.



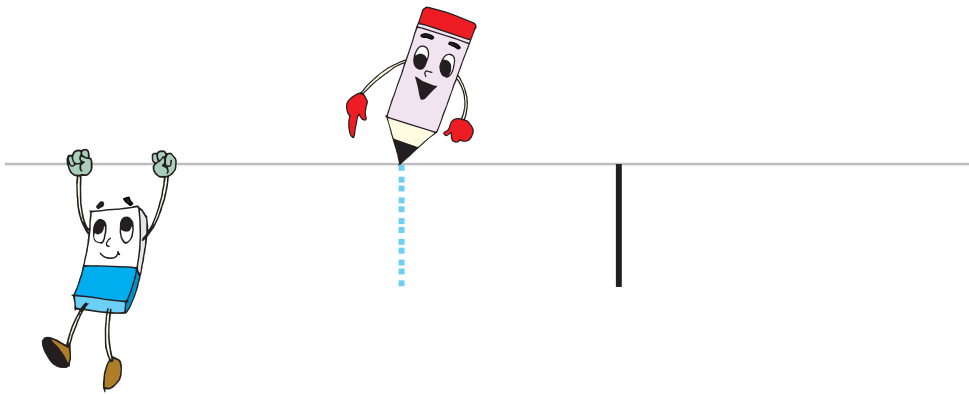

کامل کن. 



کامل کن و رنگ بزن. 

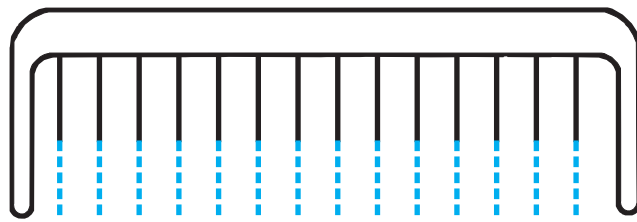

بنویس. 



خدا نگه دار!

کامل کن.

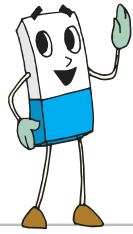

کامل کن و رنگ بزن.

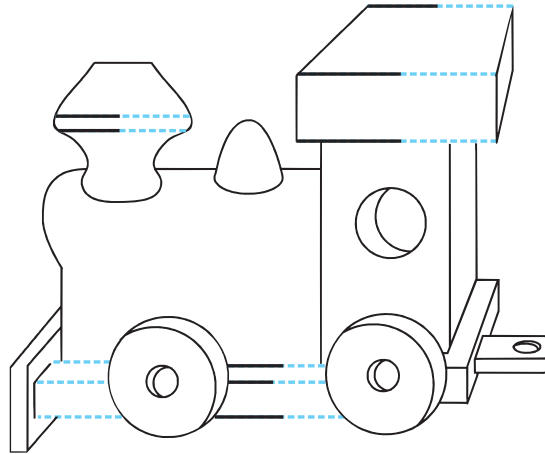



بنویس.



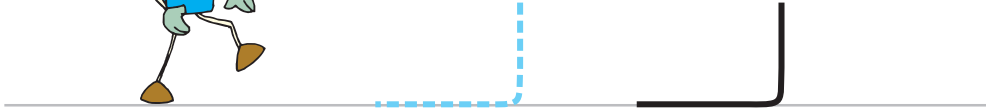
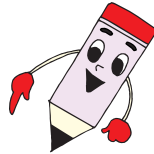
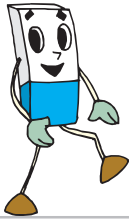

کامل کن. 



کامل کن و رنگ بزن. 

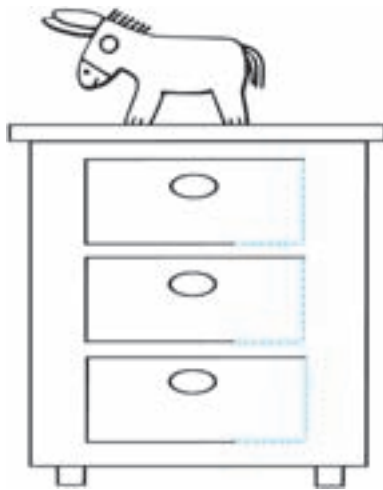

بنویس. 



سلام
دوست من!

کامل کن.

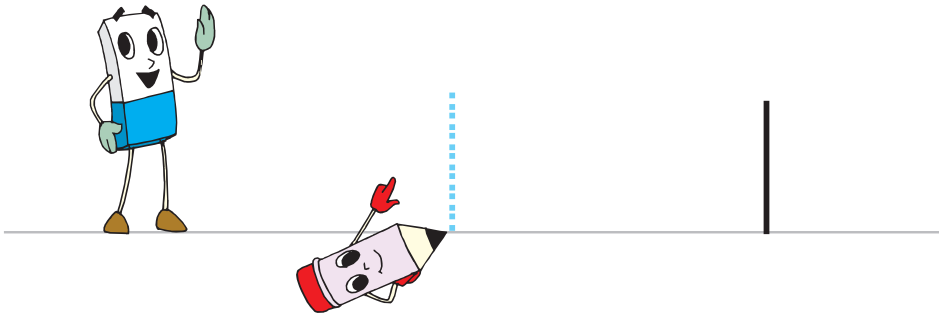

کامل کن و رنگ بزن.

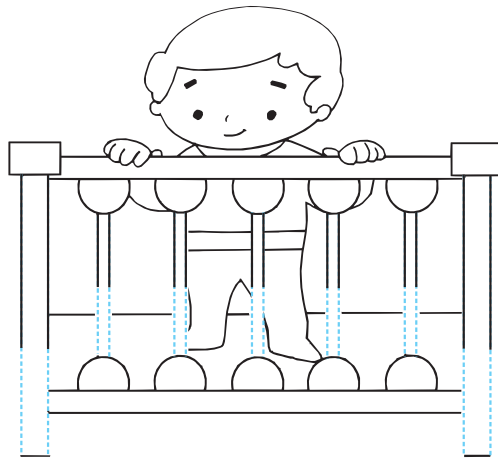

بنویس.





Handwriting practice lines with vertical dashed lines for tracing and a solid line for writing. A red arrow points upwards at the end of the lines.



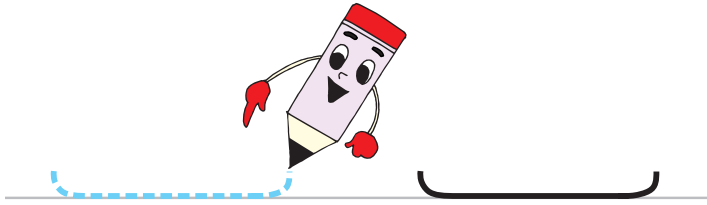

کامل کن. 



کامل کن و رنگ بزن. 

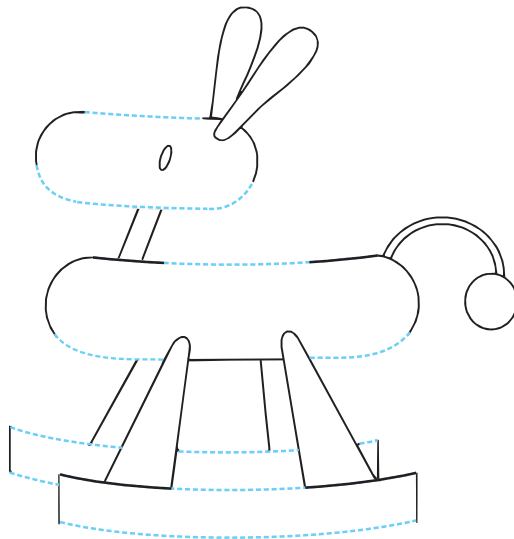

بنویس. 



سلام،
روز به خیر!

کامل کن.

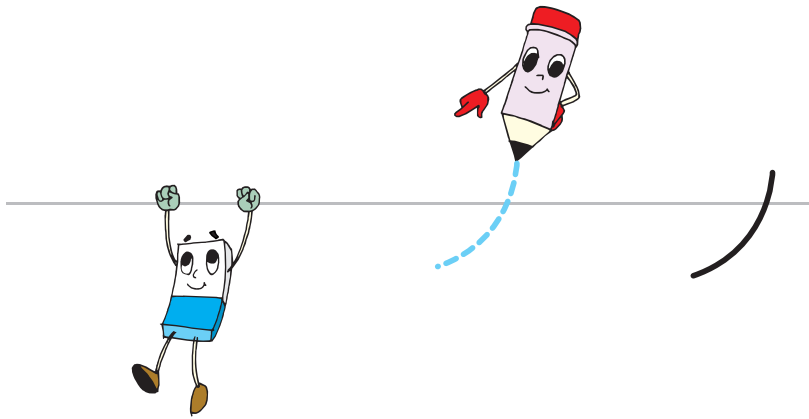

کامل کن و رنگ بزن.

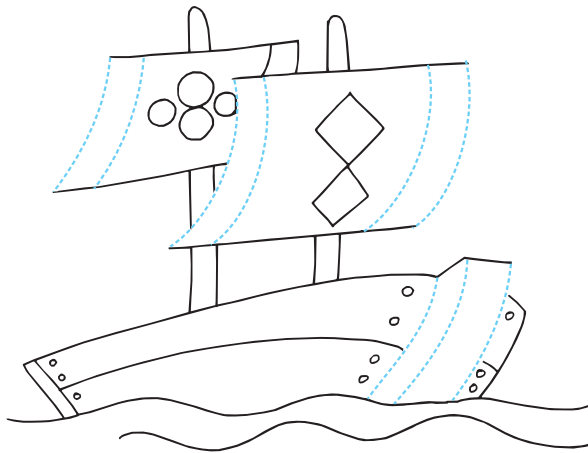

بنویس.



خسته نباشی!



کامل کن. 

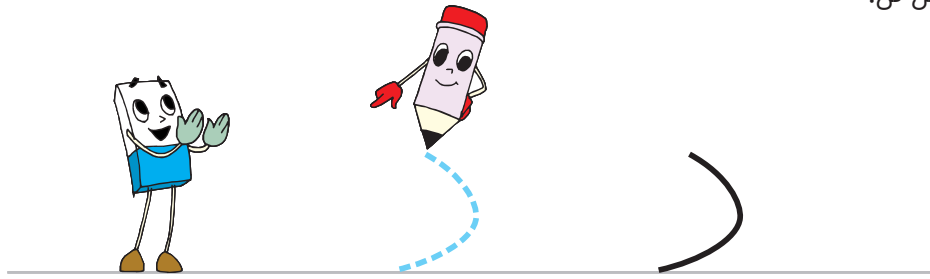

کامل کن و رنگ بزن. 

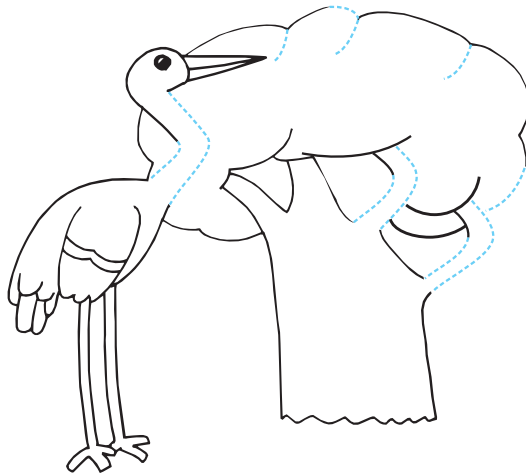

بنویس. 

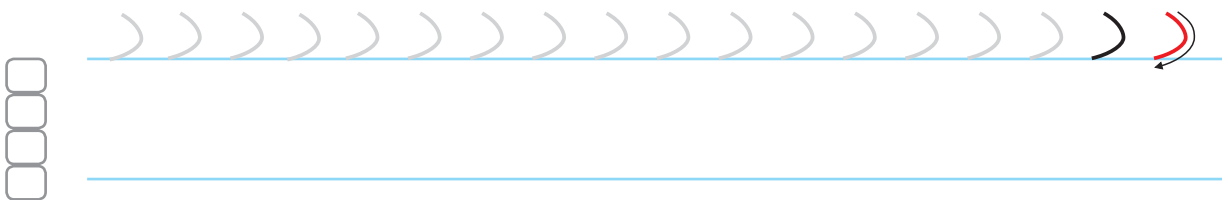

سلام،
روز به خیر!

کامل کن.

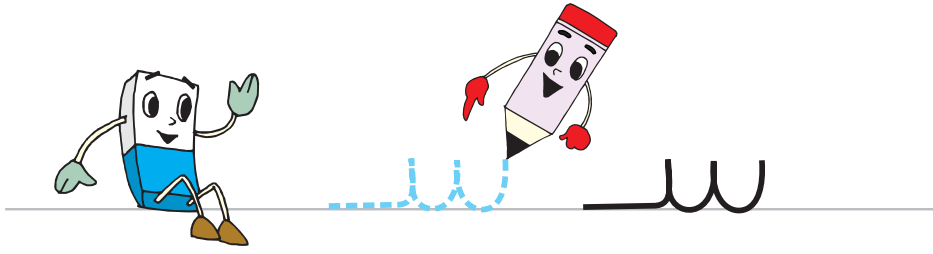

کامل کن و رنگ بزن.

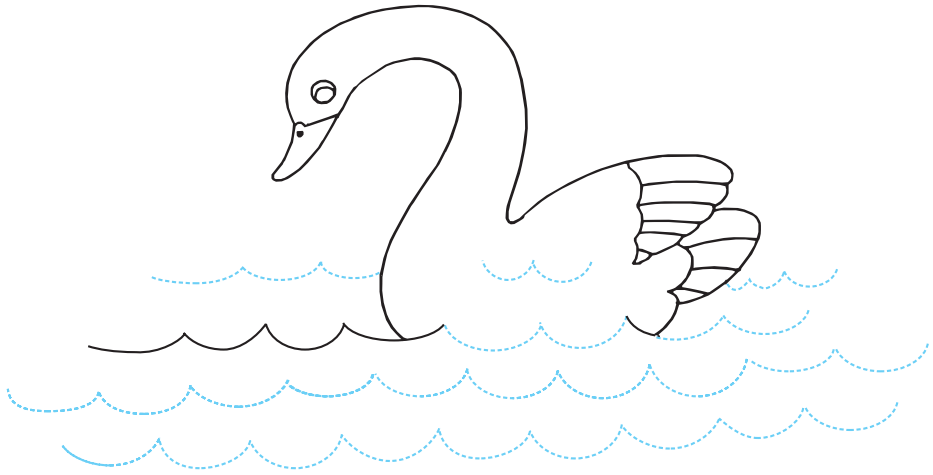

بنویس.



آفرین!



کامل کن. 

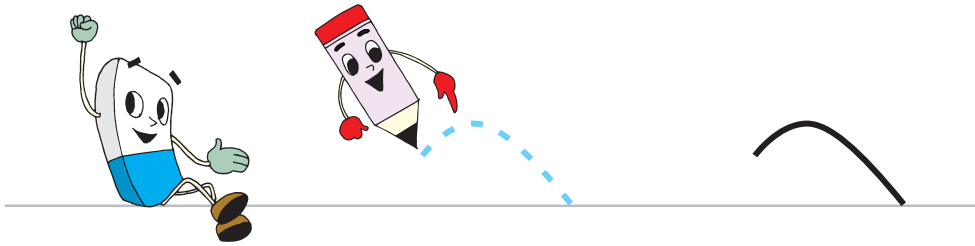

کامل کن و رنگ بزن. 

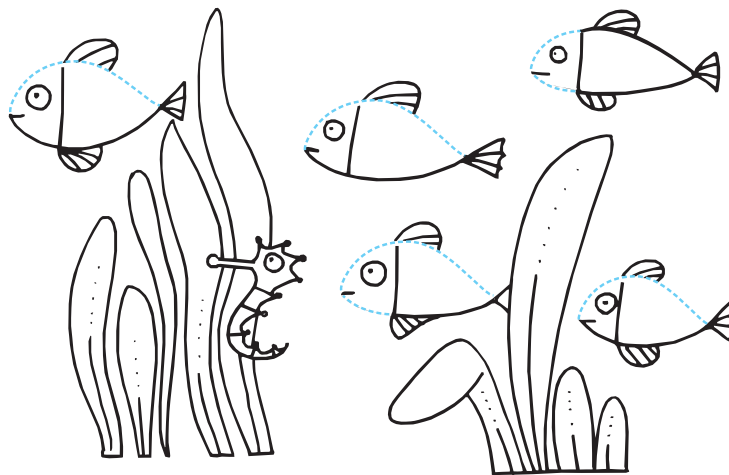

بنویس. 



سلام،
روز به خیر!

کامل کن.

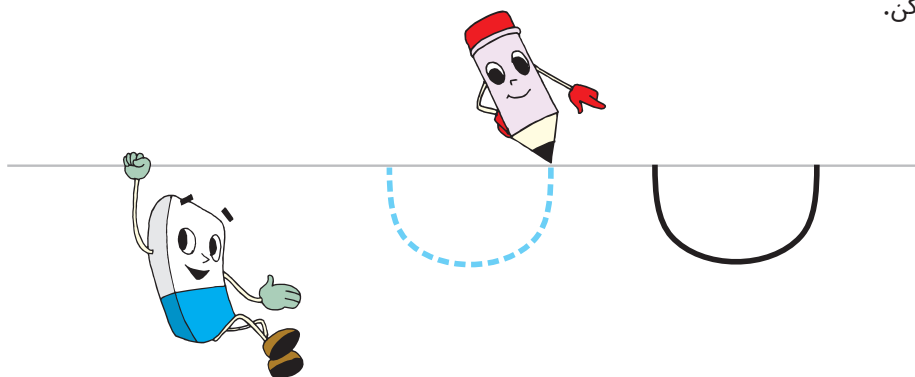

کامل کن و رنگ بزن.

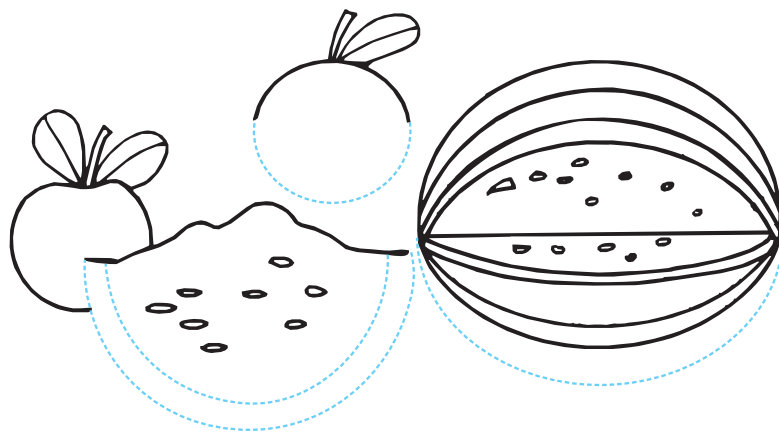

بنویس.

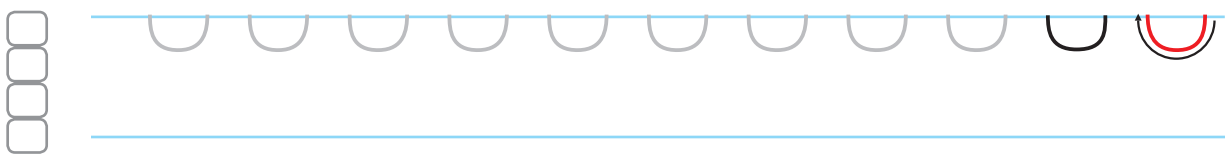

آفرین عزیزم!



کامل کن. 

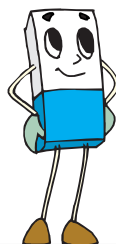

کامل کن و رنگ بزن. 

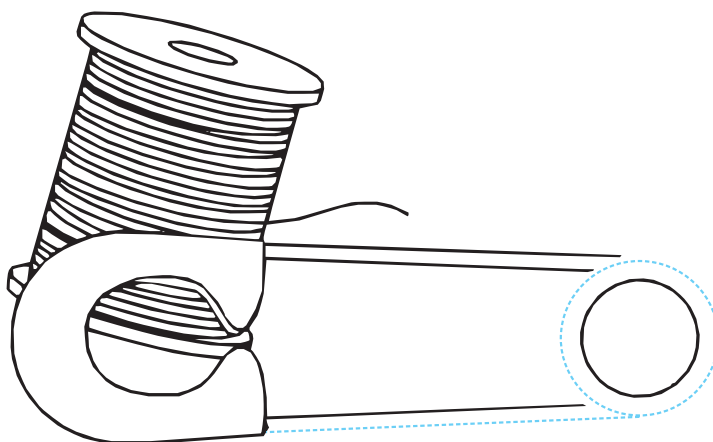

بنویس. 



روزت به خیر!

سلام
هم شاگردی!

کامل کن.

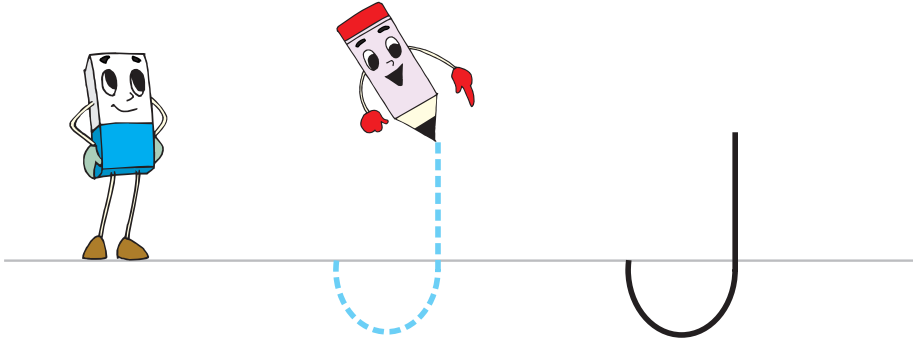

کامل کن و رنگ بزن.

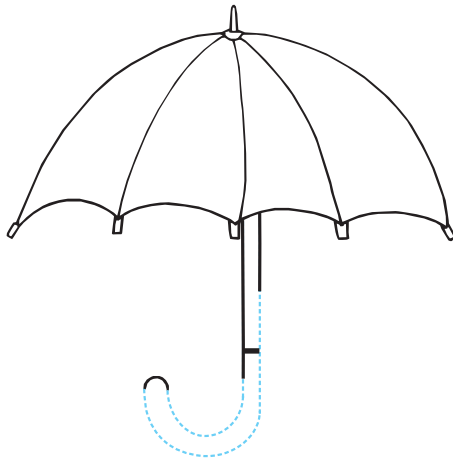

بنویس.



با هم دوست
باشیم!



کامل کن. 

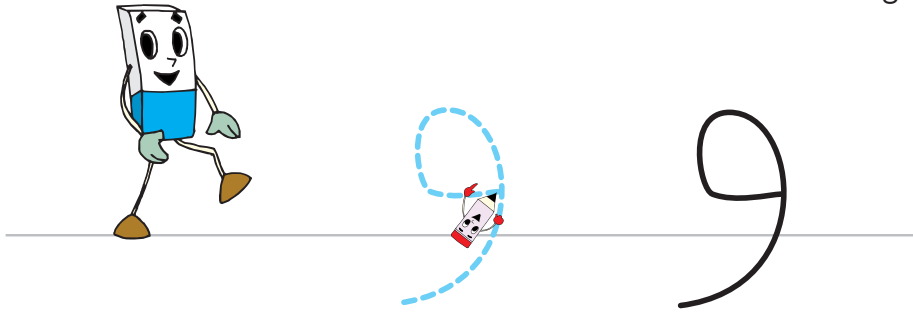

کامل کن و رنگ بزن. 

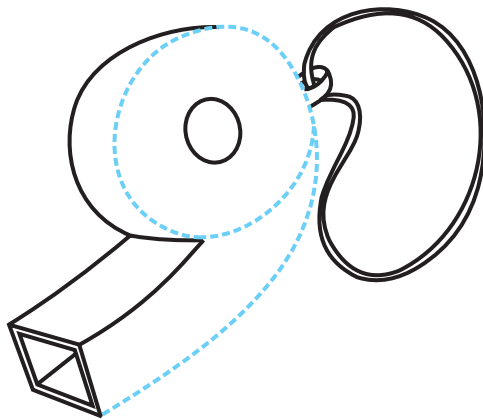

بنویس. 

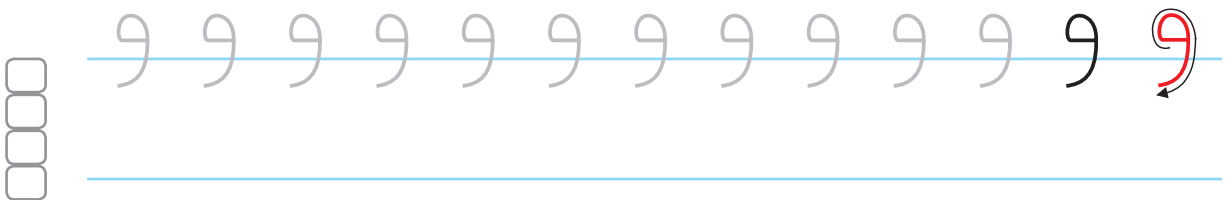

دوست من
سلام!

کامل کن.

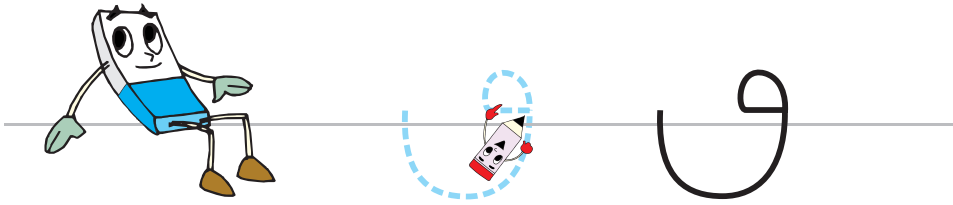

کامل کن و رنگ بزن.

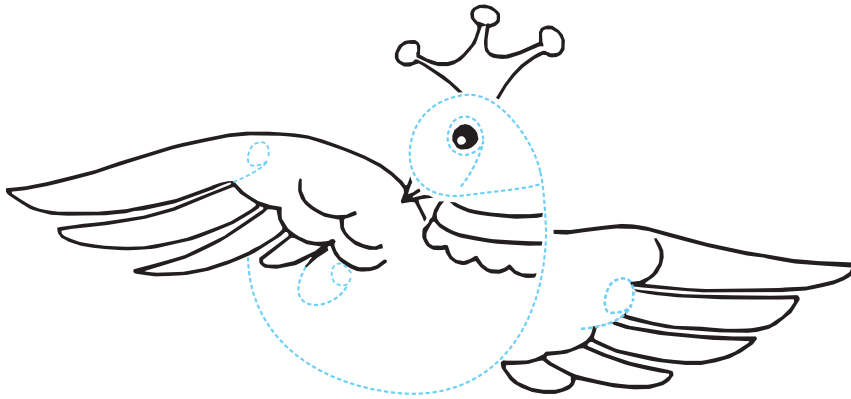

بنویس.

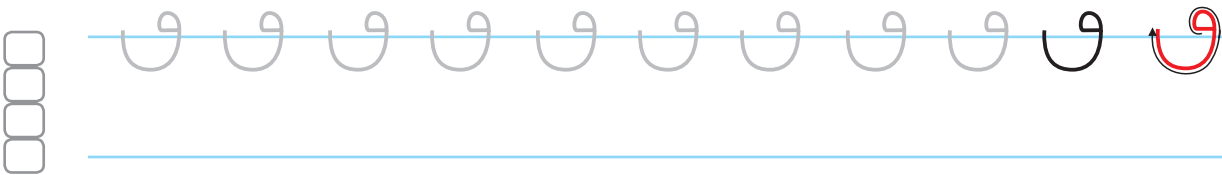



کامل کن. 



کامل کن و رنگ بزن. 

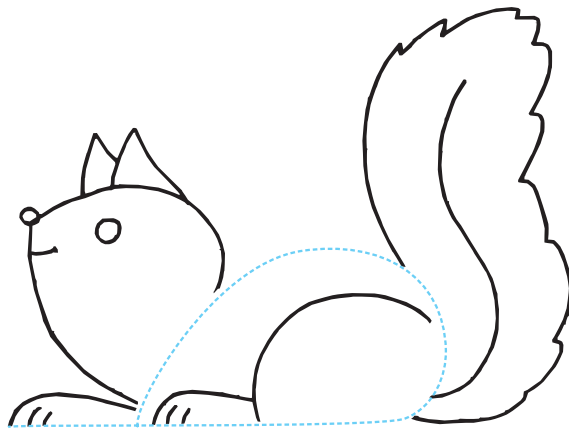

بنویس. 

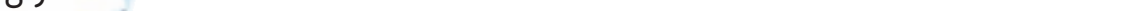

کامل کن.



سلام!

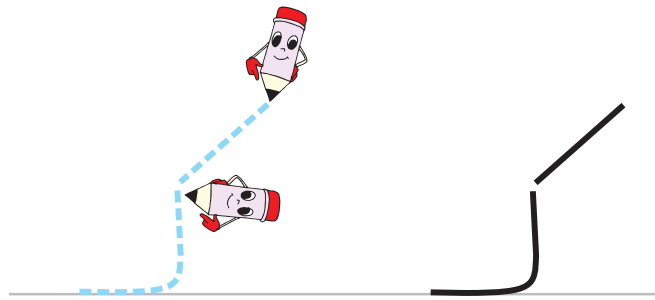

کامل کن و رنگ بزن.

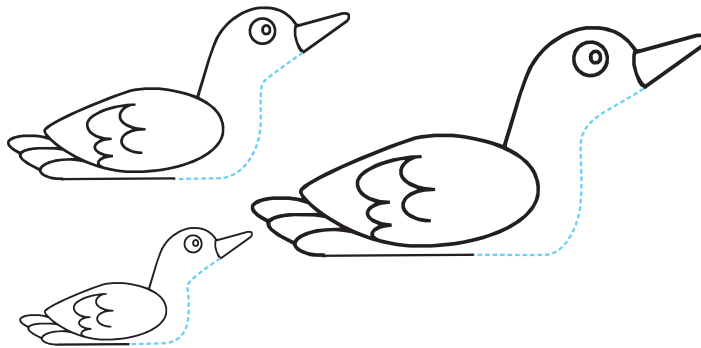



بنویس.



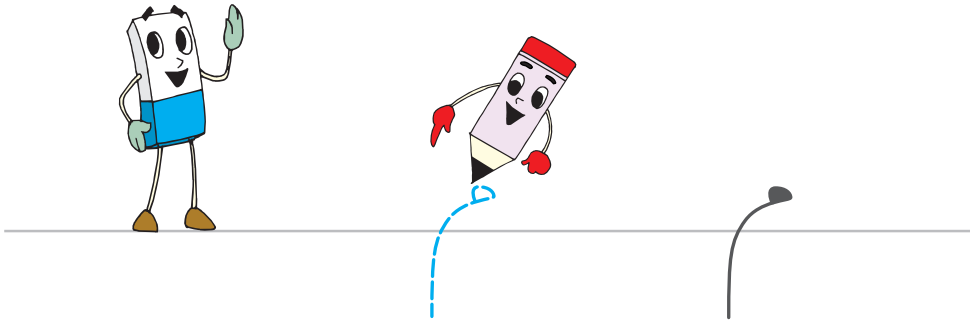

کامل کن. 



کامل کن و رنگ بزن. 

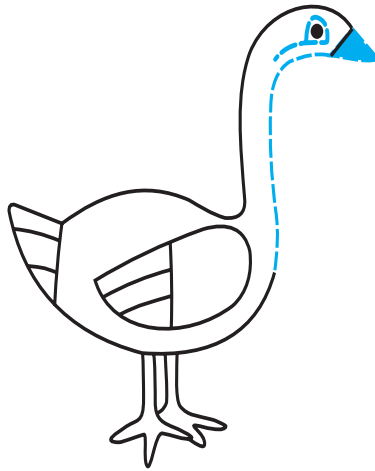

بنویس. 

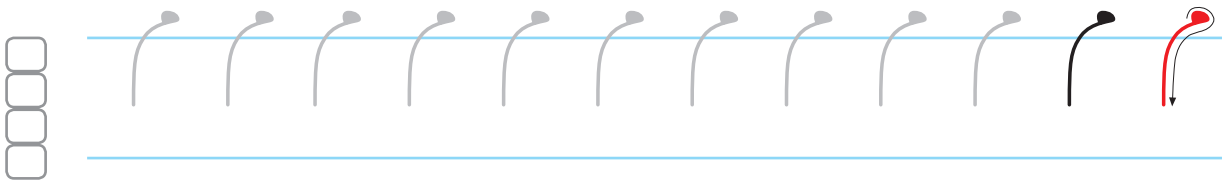

هم کلاسی
سلام!

کامل کن.

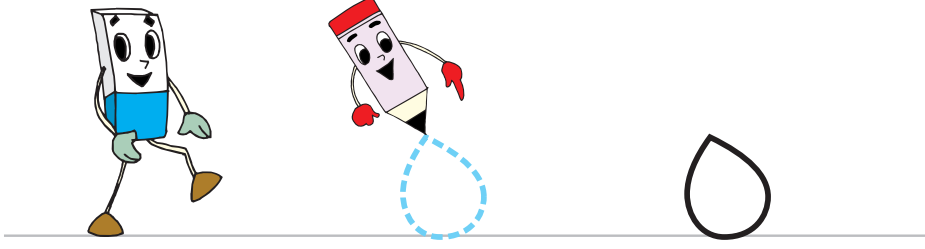

کامل کن و رنگ بزن.

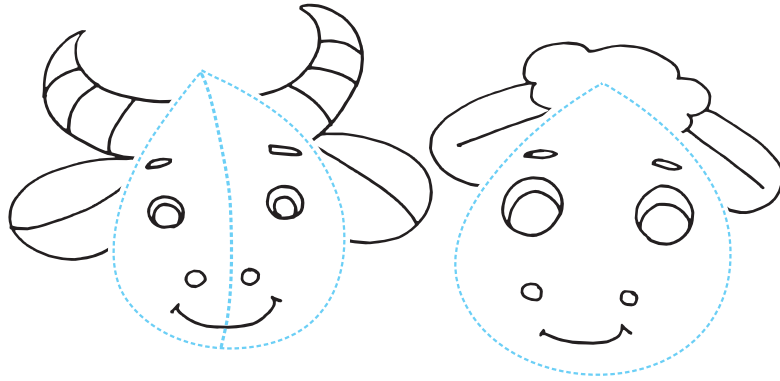



بنویس.



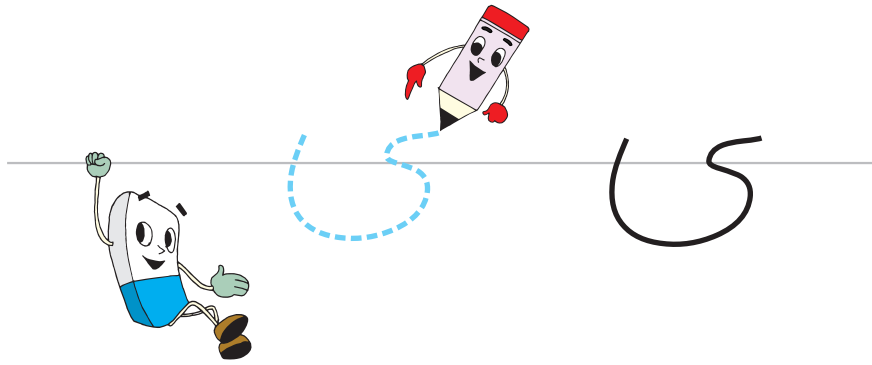

کامل کن. 



کامل کن و رنگ بزن. 

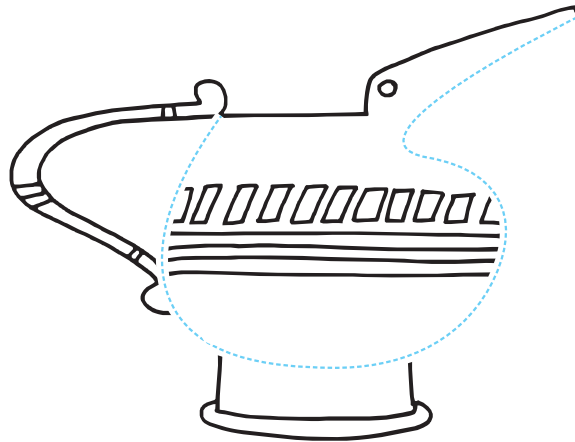

بنویس. 



ی ی ی ی ی ی ی ی ی ی ی



شادباش!



سلام
فرزندم

بنویس.

س س س س س س س س س س

Blank handwriting lines for practicing the letter 'س'.

ح ح ح ح ح ح ح ح ح ح

Blank handwriting lines for practicing the letter 'ح'.

ح ح ح ح ح ح ح ح ح ح

Blank handwriting lines for practicing the letter 'ح'.



خیلی خوب!



ب ب ب ب ب ب ب ب

ه ه ه ه ه ه ه ه

و و و و و و و و

